

# Corded 2" Faux Wood Blinds Instructions

**Note: It is best to read through the installation instruction completely prior to beginning your installation.**

## CORDED 2" FAUX WOOD BLINDS PARTS

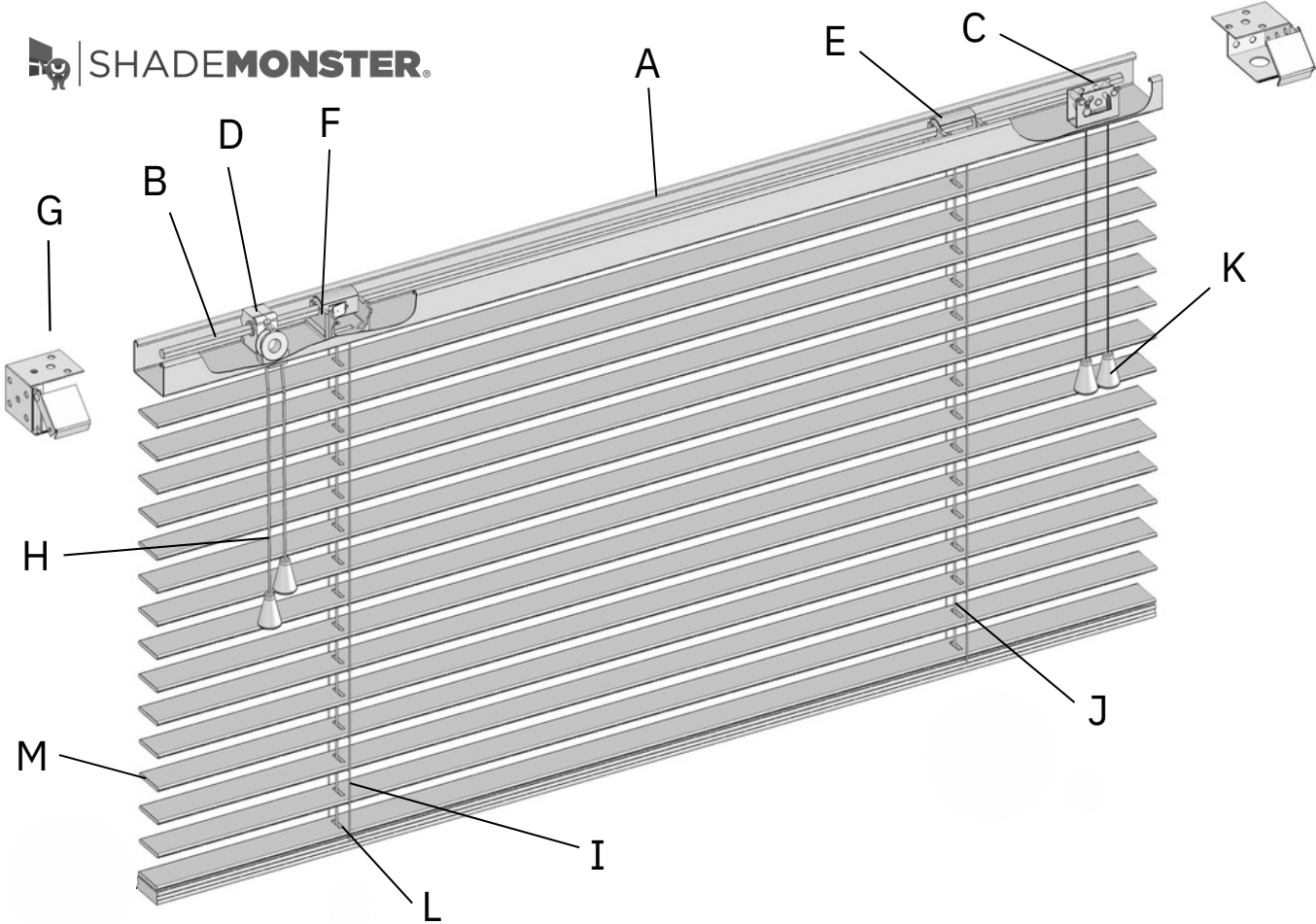

## TOOLS THAT YOU WILL NEED



Cordless Drill

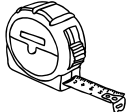

Tape Measure



Pencil



Step stool or ladder

# INSTALLATION STEPS

## 1. DETERMINE BLIND POSITION

Mark the bracket positions depending on if you ordered inside or outside mount

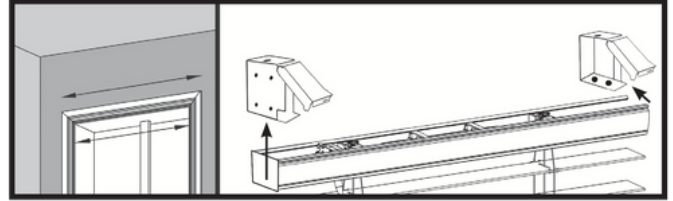

## 2. INSTALL MOUNTING BRACKETS

Install mounting brackets using screws included in component package.

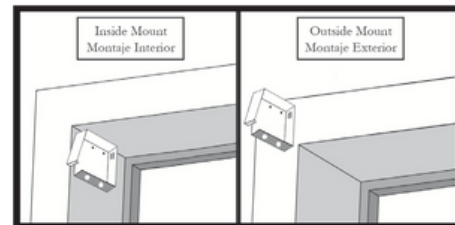

## 3. ATTACH VALANCE CLIPS

Attach valance clips to headrail.

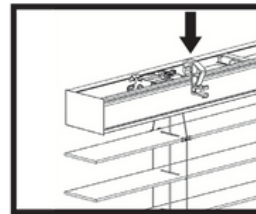

## 4. INSERT WAND HOOK

Insert wand hook into the tilter as shown below.

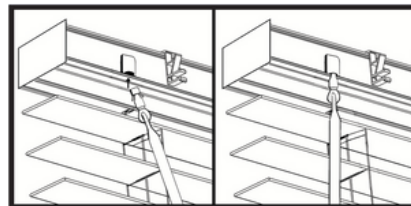

## 5. MOUNT YOUR BLIND

Mount your blind by inserting the headrail ends into the open mounting brackets.

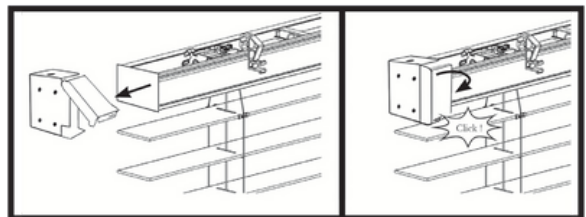

## ENJOY YOUR NEW WINDOW TREATMENTS

Still need help? ShadeMonster can guide you through the process and answer any questions during installation! Chat live or watch our quick video to see how it's done.

 +1 (866) 206 8056

 [www.shademonster.com/pages/measure-install](http://www.shademonster.com/pages/measure-install)

 [help@shademonster.com](mailto:help@shademonster.com)